

Common Cap Interface

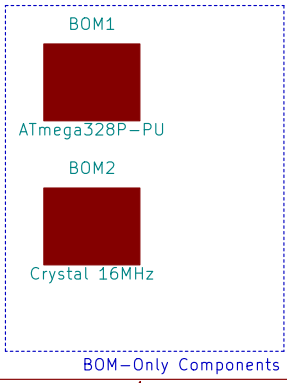
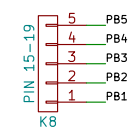
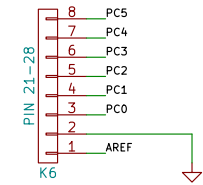
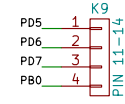
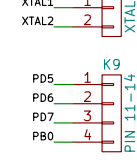
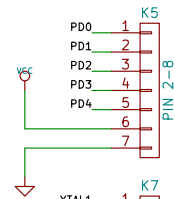
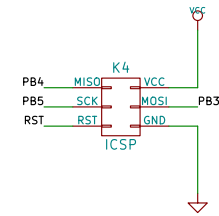
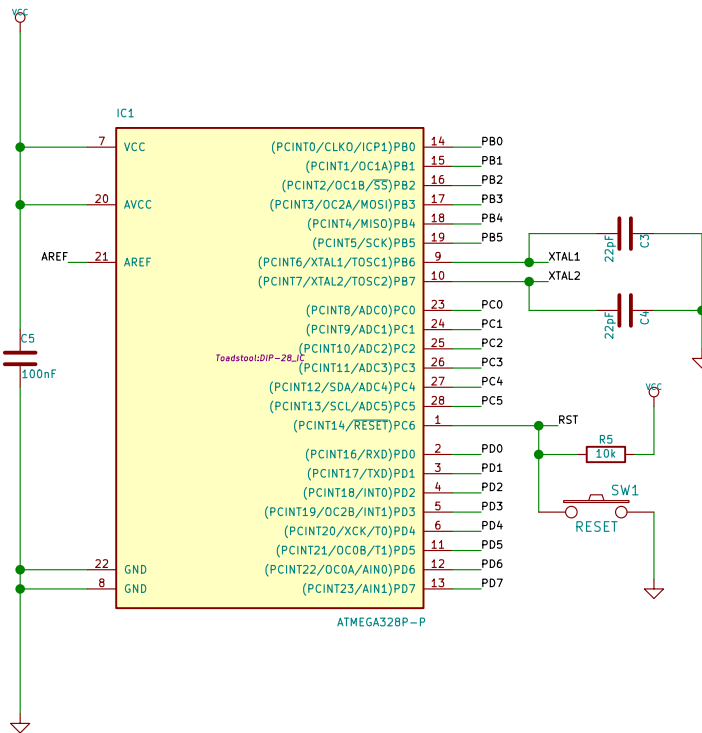

Crash-Bang Prototyping	
Sheet: /	
File: toadstool mega328.sch	
Title: Toadstool Mega328	
Size: A4	Date:
KiCad E.D.A. kicad (2015-04-22 BZR 5620)-product	Rev: 0.3
	Id: 1/1